

# nuZeo 6C

## Quickstart Manual



**EN** This manual is available in multiple languages.  
You can find the latest version in your  
preferred language here:  
[www.nubert.de/en/downloads](http://www.nubert.de/en/downloads)



**DE** Die neuesten Bedienungsanleitungen und weitere  
hilfreiche Informationen finden Sie hier:  
[www.nubert.de/downloads-nuzeo-6c](http://www.nubert.de/downloads-nuzeo-6c)



**nubert**<sup>®</sup>

**Thank you for choosing Nubert speakers!**

**In this user manual, we explain the setup, connections, and commissioning of the system. Furthermore, the entire range of functions and operation is listed so that you can achieve the optimum sound quality and functionality and fully enjoy your speakers.**

**Be sure to also read the additional enclosed safety instructions!**

**We wish you much joy with your new speakers!**

### **Cold, sound, and operational safety**

When speakers or other electronic devices are brought from a cold environment into a warm room, condensation can form inside – there is a risk of defect or electric shock! Additionally, low temperatures can impair the mobility of parts inside the speaker, such as membranes. Wait at least 6 hours before turning on the device until it has reached room temperature and is dry! Your new speaker will reward you with the superior sound quality you rightly expect from Nubert.

## 1 Placement

For horizontal placement of the speaker, four vibration-damping elastic buffers are attached to its bottom, ensuring a solid stand on various furniture pieces.

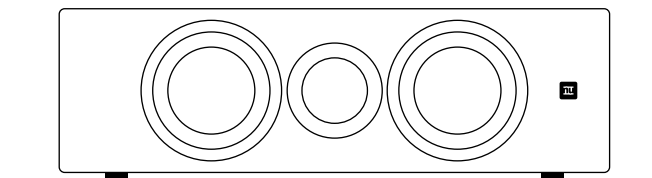

The nuZeo speakers are high-quality and very neutral-sounding bass reflex active speakers. However, every speaker is subject to the various influences of room acoustics.

Therefore, please observe the following general placement guidelines:

- Rear bass reflex openings should have a few centimeters of distance from the wall or adjacent furniture fronts to avoid airflow noise. With a generous distance to side and rear walls, an emphasis in the bass and midrange area is also reduced.
- The most natural sound is achieved when the tweeter is at ear level. However, even 20 degrees above and below the tweeter axis still results in a homogeneous sound image. If your active speakers need to be placed higher or lower, they should be angled so that the tweeters are directed at the listening position.
- When placed on shelves, the best sound is achieved when the front edge of the box is flush with the shelf edges or even slightly overhangs.

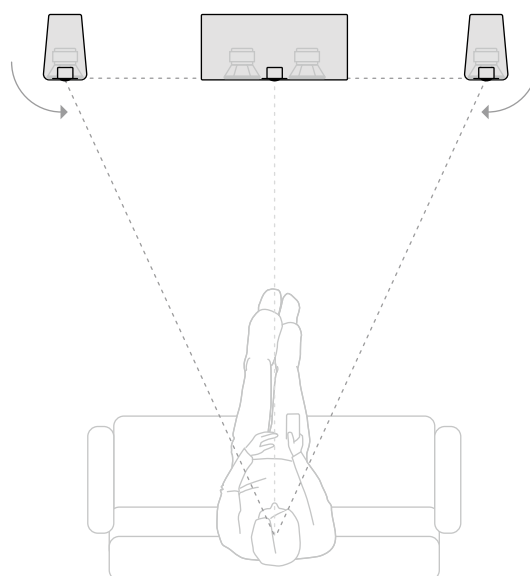
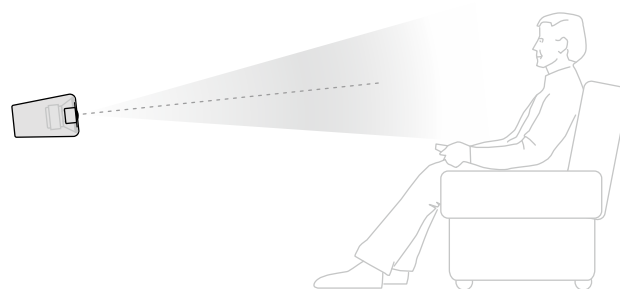

### Sound adjustment

To adapt the sound of the speakers to your room or placement, various adjustments can be made using the Nubert X-Remote App (see page 8). Connect the app to the speakers and navigate to the following menu items depending on the desired setting:

#### > advanced > system hp

to reduce particularly low frequencies that tend to drone.

#### > room calibration

for automatic calibration of the speaker to your listening position.

#### > sound

for general sound adjustments.

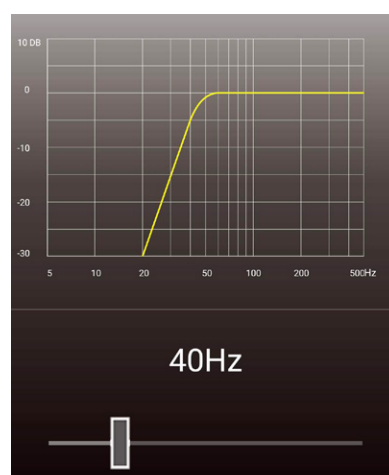

## 2 Signal connections

If the speaker is to be supplied with audio signals only via wireless (X-Connect or X-Connect Surround), you can skip this step. If your speakers are to be supplied with audio signals via cable, connect these cables first. The following options are available:

### XLR (analog balanced)

Each speaker is directly supplied with the audio signal and controlled individually.

### AUX (analog unbalanced)

**Option A:** Each speaker is directly supplied with the audio signal and controlled individually. (Factory setting: Kanal L\_in is active)

**Option B:** Alternatively, both channels can be connected to one speaker of a stereo pair. This speaker then acts as the master speaker. The audio signal of the second channel can be passed on via digital coaxial cable or X-Connect wireless connection.

### AES / EBU (digital balanced)

### SPDIF Coaxial 1 & 2 (digital unbalanced)

The signal cable is connected to one speaker of a stereo pair. This speaker then acts as the master speaker. The audio signal of the second channel can be passed on via digital coaxial cable or X-Connect wireless connection.

### ⚠ Attention!

Make changes to the speaker cabling only when the device is turned off!

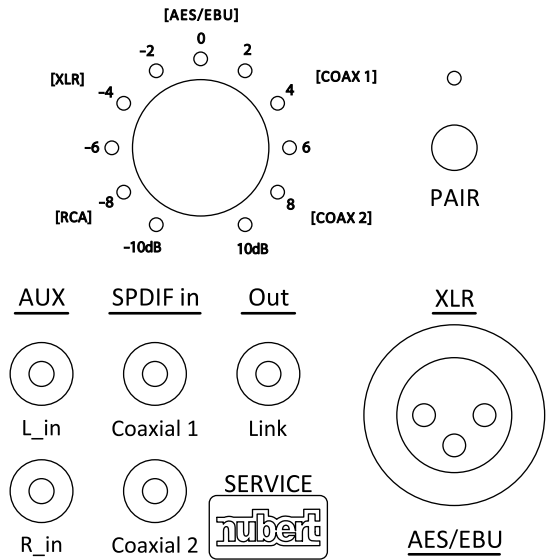

## 3 Power connection

Connect the included power cable to the power socket to establish the connection to the power network. Turn on the speakers by flipping the switch next to the power socket to the ON position.

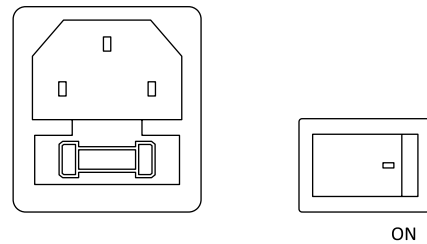

## 4 Wireless pairing with a preamplifier

Excellent wireless stereo solutions can be set up with Nubert devices such as the high-end preamplifier nuControl X or integrated amplifiers like nuConnect ampX or ampXL. Traditional preamplifiers can also be supplemented with a nuConnect trX wireless adapter to save cable paths to active speakers. Surround solutions can also be set up with the nuZeo speakers. For this purpose, the nuXinema preAV preamplifier is recommended.

### Pairing process directly on the speaker (Factory State)

Press and hold the button labeled **PAIR** for 3 seconds to start the pairing process.

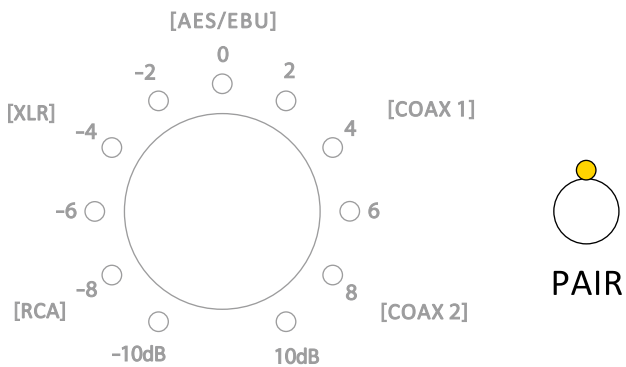

### Pairing process via X-Remote App

The pairing process can also be started via the X-Remote App (see page 8). Connect the app to the relevant speaker, navigate to the main menu of the speaker, select **> setup**, and choose **> wls slave**.

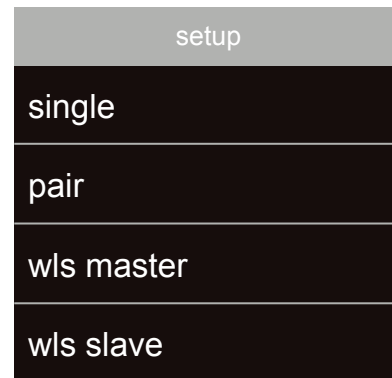

In both cases, the speaker searches for a compatible wireless master (e.g., nuControl X, nuXinema preAV) for 2 minutes, indicated by rapid blinking of the white LED.

Start the pairing process on the transmitter as well. This is usually done by selecting the entry **wls master** in its **setup** submenu. Refer to the transmitter's user manual if necessary.

The devices connect; a successful connection is indicated by a steady white LED.

## 5 Channel selection

Finally, the appropriate channels must be assigned to the speakers.

- Start the X-Remote App (see page 8) and connect it to the master speaker or the transmitter.
- Navigate to the main menu of the app, select the entry > **channel config**. Here, you get an overview of the speakers and can select the channels to be played back for each speaker.

**Note:**

If you have connected the speakers to a preamplifier such as a nuControl X or nuXinema preAV via X-Connect, the channel selection is made on that device.

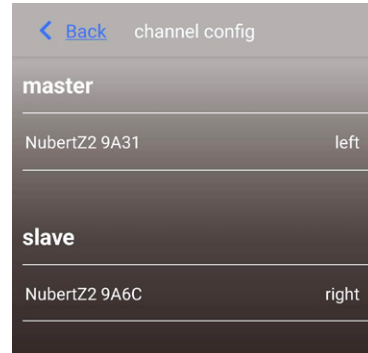

## 6 Source selection and sensitivity

The selection of input and sensitivity can be made directly using the rotary control on the back of the speaker.

**Press**

To switch between sensitivity and input, press the rotary control.

- Sensitivity LEDs light up green
- Input LEDs light up blue

**Rotate**

By rotating the control, the respective parameter can be varied. The adjustment range includes:

- Input: The 5 directly connected sources are selected via the rotary control. The X-Connect wireless input is automatically selected by pairing the speaker.
  - Sensitivity: -10 to +10 dB in 1 dB steps
  - The current value is indicated by the LEDs around the rotary control. The LED allows the display of intermediate steps through two different brightness levels. If the LED lights up fully, the exact value next to the LED is set. If the LED lights up with reduced brightness, the smaller intermediate value is set.
- Example: If the LED in the illustration on the right lights up with reduced brightness, a sensitivity of -5 dB is set.

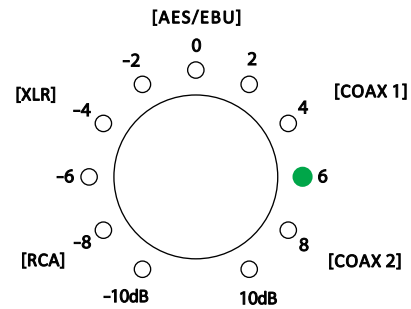

Example: Sensitivity +6 dB

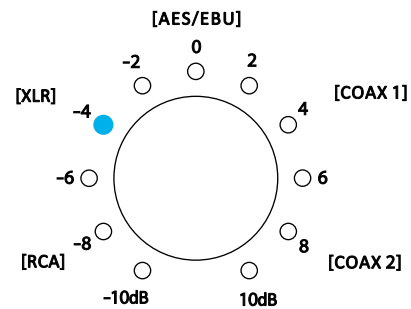

Example: Input XLR

## 7 Factory reset

To reset the speaker to factory settings, it must first be turned off using the switch on the back of the device. Wait 10 seconds and turn it back on. Within 3 seconds after turning it on, both buttons on the back of the device (SOURCE/PAIR and the rotary control) must be pressed and held for at least 8 seconds.

All settings are now back to the factory state.

Alternatively, the factory reset can also be performed via the X-Connect App. Navigate to the menu item > **advanced** > **default** and confirm the security prompt.

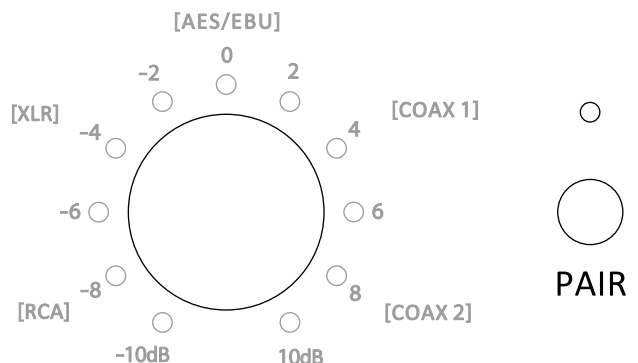

## Nubert X-Remote App

To control the speakers, you can use the Nubert X-Remote App, which you can download for free from the App Store or Play Store on your mobile device.

With the X-Remote App, you can conveniently make all settings from your listening position. The app also offers additional options that cannot be set directly on the speaker. In addition to the functions already listed in the manual, the following are particularly noteworthy:

### Password assignment

When you first connect the app to a suitable device, you may be prompted to enter a password. The default password is 0000. In the menu under

> **settings** > **advanced** > **password**

you can set a different password to protect the device from unauthorized access.

If the device is reset to factory settings (default), the password is also reset to 0000.



### X-ROOM CALIBRATION









Interference such as droning or dips in the bass range is often caused by room influences. The X-Room Calibration allows optimization of the frequency response in the bass range, providing an optimal listening experience with punchy, dry, and responsive bass. To get the most out of this automatic calibration, connect the app to the device and perform the calibration directly at your listening position. The speakers play test noise, which is picked up by your smartphone's microphone. Based on these measurement data, the app calculates a correction curve and transmits it back to the speaker, which adjusts the frequency curve during playback so that you enjoy the optimal sound image at the listening position.

### Hinweis:

For Android devices, the USB measurement microphone „Nubert XRC Android Interface“ is required to use X-Room Calibration.

## Status LED

The status LED is located on the front of the speaker. During operation, it indicates the selected input by its color. In standby mode, the LED lights up with reduced brightness.

Input:	Status LED Color:
Wireless	 Blue
AUX	 Green
XLR	 White
AES/EBU	 Yellow
COAX 1	 Orange
COAX 2	 Red

### Note:

The behavior of the LED can be influenced via the X-Remote App. Navigate to the menu item > **advanced** > **display** > **light**



---

Stand: 19.06.2024

Technical specifications, errors, and omissions excepted

Our general terms and conditions (GTC) can be found on our website [www.nubert.de/en/gtc/](http://www.nubert.de/en/gtc/)



Nubert electronic GmbH  
Nubertstr. 1  
73529 Schwäbisch Gmünd  
Deutschland

E-Mail: [info@nubert.de](mailto:info@nubert.de)  
Hotline: +49 (0)7171 8712-0  
[www.nubert.de](http://www.nubert.de)